

1/4-20 UNC-2B X .38 EFF. THREADS - 4 HOLES AT 90° APART ON A 3.75 BOLT CIRCLE.

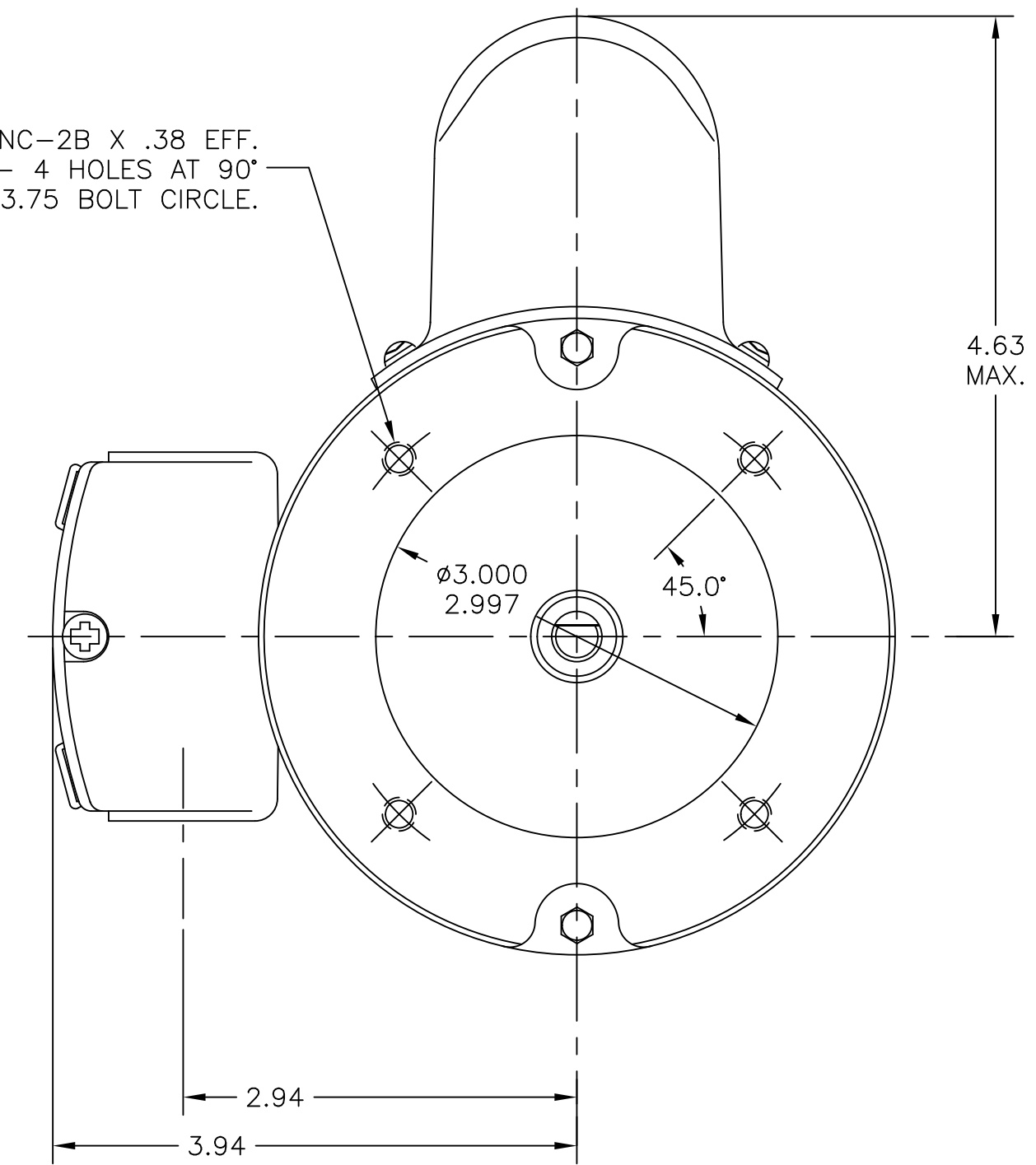

FRAME	'C'	'AG'	'BV'
4212	8.00	6.69	4.91
4216	8.00	6.69	4.91
4220	9.13	7.82	6.03
4225	9.13	7.82	6.03